

Modular General Purpose Tent System 1

[8340-01-456-3633 Small Camouflage Green Shade #483](#)

The diverse mission of the army requires a weatherproof multipurpose shelter for both military operations and civilian. The Modular General Purpose Tent System (MGPTS) incorporates the latest design and manufacturing technologies to provide a multipurpose weatherproof shelter for any environment. The MGPTS is a pole supported, modular, and more habitable replacement for the current GP small tents. It utilizes tensioned fabric to create a structure which distributes wind, rain and snow loads from the fabric directly to the support system. Because of this design, the MGPTS distributes loads more efficiently with lighter support systems than conventional GP tents. It can serve as a billeting, command and control, unit supply, or field service shelter.



SYSTEM 1 KEY FEATURES:

- Camouflage green
- 324 square feet of floor space
- Modular and extendible in length indefinitely in 18' increments
- Tensioned fabric design, vinyl coated polyester fabric
- Blackout capable
- Leak proof heat sealed seams

System 1 Description:

The small MGPTS is 18 feet wide, 18 feet long, weighs 468 pounds, and has 324 square feet of floor space. It can be setup in 27 minutes by 4 people. This system requires an area space being at least 34 feet long, 34 feet wide, and 12 feet high for tent setup. The small MGPTS can be extended indefinitely by adding 18 foot intermediate sections.

Modular General Purpose System 1 includes the following:

	NSN	DESCRIPTION	QUANTITY
1.	8340-01-477-9569	Camouflage Green #483 Fabric Assembly, End Section, 9'	2
2.	8340-01-477-9566	Pole, Side, W/Guy Line Assemblies	6
3.	8340-01-477-9525	Pole, End W/Guy Line Assemblies	2
4.	8340-01-477-9570	Pole, "Y" Adjustable	1
5.	8340-01-478-0133	Stake, Hold Down 36" Wood	16
6.	8340-01-478-0136	Stake, Hold Down 12" Black	24
7.	8340-01-477-9561	Bag, Fabric Assembly End Section	2
8.	8340-01-477-9564	Bag, End Pole	1
9.	8340-01-491-0486	Kit, Repair, Field Expediant	1

PRODUCT SPECIFICATIONS:

- Dimensions: 18'Length X 18'Width X 11'5"Ridge Height and 7' Eave Height
- Floor Area: 324 square feet
- Weight: 468 pounds
- Color: Camouflage Green
- Set-up Time/# of Persons: 27/4
- Strike Time/# of Persons: 27/4
- Shipping Cube: 58 cu. Ft.

The Technical Manual for this tent is TM-10-8340-240-12p.

NSN	Description	Quantity
8340-01-456-3633	Small Camouflage Green Shade #483	1

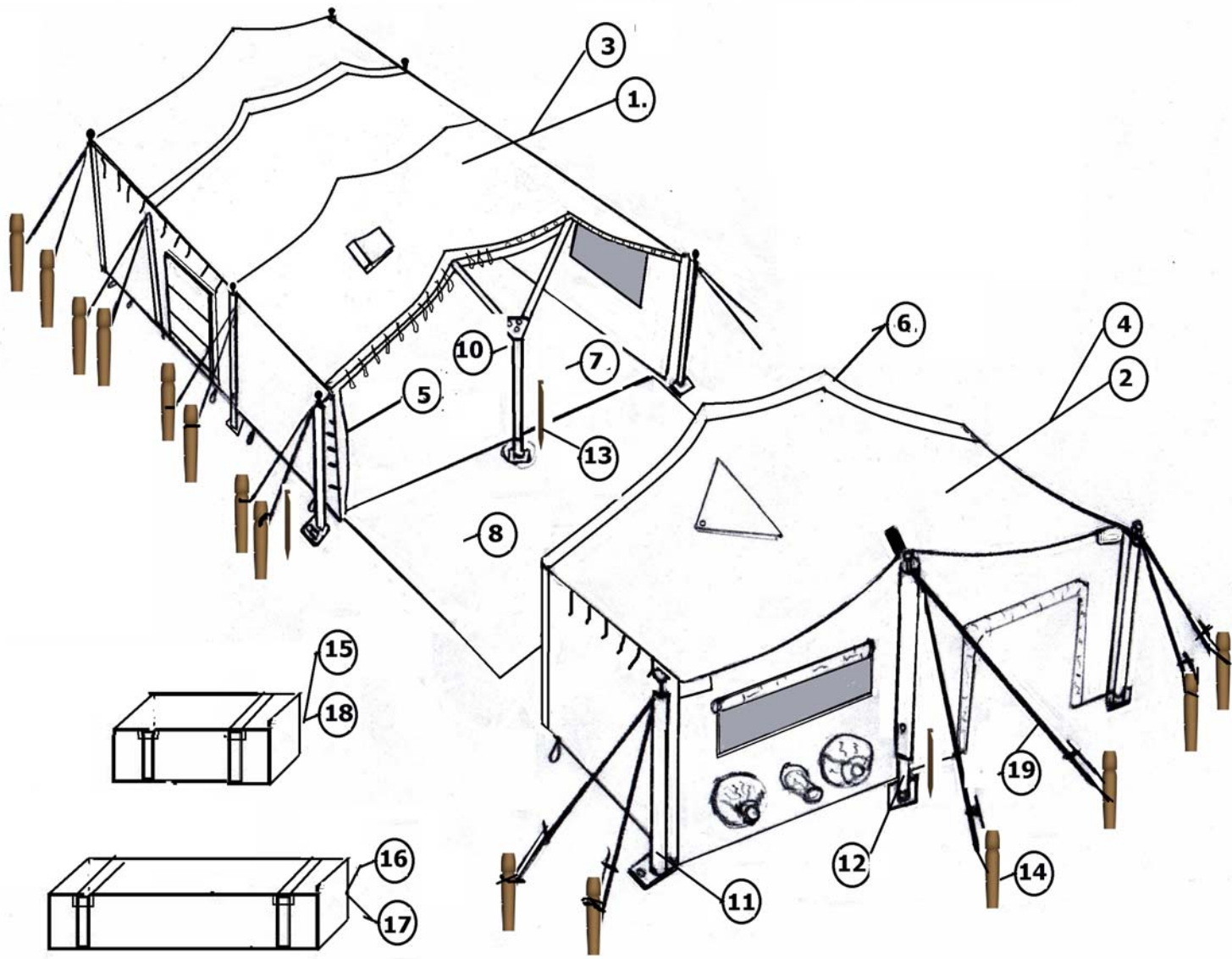

	Cut-A-Way View	
Find #	NSN	Nomenclature
1.	8340-01-477-9567	Camouflage Green #483 Fabric Assembly, Intermediate Section, 18'
2.	8340-01-477-9569	Camouflage Green #483 Fabric Assembly, End Section, 9'
3.	8340-01-491-1463	Desert Tan #459 Fabric Assembly, Intermediate Section, 18'
4.	8340-01-491-1465	Desert Tan #459 Fabric Assembly, End Section, 9'
5.	8340-01-477-1390	Liner, Intermediate Section, Single Ply Fabric
6.	8340-01-491-1392	Liner, End Section, Single Ply Fabric
7.	8340-01-491-1449	Floor, Intermediate, Coated Cloth, Black
8.	8340-01-477-1397	Floor, End Section, Coated Cloth, Black
10.	8340-01-477-9570	Pole, "Y" Adjustable
11.	8340-01-477-9566	Pole, Side, W/Guy Line Assemblies
12.	8340-01-477-9525	Pole, End W/Guy Line Assemblies
13.	8340-01-478-0136	Stake, Hold Down 12" Black
14.	8340-01-478-0133	Stake, Hold Down 36" Wood
15.	8340-01-477-9563	Bag, Fabric Assembly Mid Section
16.	8340-01-477-9562	Bag, Mid Pole
17.	8340-01-477-9561	Bag, End Pole
18.	8340-01-477-9561	Bag, Fabric Assembly End Section
19.	8340-01-478-0022	Guy, Line, Polyester, Black, W/Slip

Test Data

Test	Description (Abbreviated)	Company Tested	Government Verified
Temperature Range, Operational	Minus 25 to plus 120 degrees F.		
Temperature Range, Storage	Minus 60 to plus 180 degrees F.		
Erect Time / # of Persons			
Strike Time / # of Persons			
Durability	Withstand 36 erect/strike cycles		
Field Life	Minimum of three (3) years		
Shelf Life	Minimum of ten (10) years		
Wind Load, Steady	Steady wind speed of 55 mph for 30 minutes and resist rain intrusion		
Wind Load, Gusts	Three occurrences of wind gusts to 65 mph during 30 minute steady wind speed of 55 mph and resist rain intrusion		
Rain, Steady	Two inches per hour for thirty minutes		
Rain, Wind Driven	Two inches per hour for thirty minutes with wind speeds of 55 MPH and with three occurrences of wind gusts to 65 MPH within the same 30 minute period		
Humidity	Ambient humidity between zero and 100%, regardless of temperature		
Salt Fog	Shall withstand exposure to a salt fog atmosphere for 18 months		
Snow Load	Ten (10) pounds per square foot for 12 hours without damage		
Detectability/Blackout Test	Five observations with night vision goggles from 300 meters and with the naked eye from 100 meters		
Condensation	Shall minimize condensation on the inside of the tent that may adversely effect personnel or loss of mission capability		
Sunlight	Withstand exposure to direct sunlight for 18 months with material temperatures up to 160 degrees F.		
Blowing Sand and Dust	Not degraded beyond use in a blowing sand and dust environment		
Insects	Shall resist physical damage from entry of insects from the exterior, including flying insects from penetrating screening mesh diameter of 0.0125 +/- 0.001		
Mildew and Fungus	Shall not sustain the growth of fungus and bacteria under any conditions, in accordance with ASTM G-21		
Petroleum Resistance	All components shall resist damage by petroleum products such as, but not limited to, diesel fuel and jet fuel		
Mechanical Shock and Vibration	In transit bag, shall withstand a simple harmonic motion amplitude of 0.03 inches, frequency from 10 to 55 Hertz for 2 hours in each of three perpendicular directions (total test time of 6 hours)		
Rough Handling/Transit Drop	In transit bag, shall withstand 6 drops from a minimum of 4 feet at -20 degrees and at 105 degrees F.		
Roll	In transit bag, shall withstand a circular synchronous mode at 300 RPM for no less than 45 minutes		
Breaking Strength	Fabric breaking strength shall be a minimum of 250 lbs in the warp and 230 lbs in the fill		
Cold Crack	Shall be resistant to cold crack at minus 60 degrees F. when tested in accordance with ASTM D2136		

Dead Load Seam Strength	Fabric seams shall withstand a 50 lb load for 4 hours at 160 degrees F. and a 100 lb load for 4 hours at room temperature		
Flame Resistance	In accordance with IAW ASTM-D 6413-99 Standard Test Method for Flame Resistance of Textile (Vertical Test)		
Lighting Support	Shall support two fluorescent field light sets or one incandescent bulb for each nine feet of floor length		
Mapboard Support	Shall provide connections for the Modular Command Post Map Board and support strap system specified by MIL-B-44381 and 5-4-5531		
Ventilation	Shall provide non-powered ventilation to maintain a comfortable interior, with an inside temperature no higher than ambient at ambient temperatures up to 90 degrees F.		
Electrical Supply Feed Through	The electrical supply feed through shall permit the passage of wire bundles up to 5 inch diameter		
ECU Feed Through	The environmental Control Unit (ECU) feed through shall permit the passage of 18 inch diameter ducts (standardized military specification design)		
Stovepipe Shield	The stovepipe shield shall permit the passage of a 4-inch diameter stovepipe (standardized military specification design)		
Windows	Standardized military specification design		
Wrappers, Transport/Storage Covers	Standardized military specification design		

Spare Parts & Options for the MGPTS:

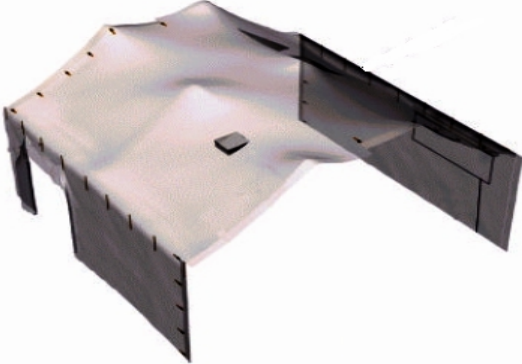
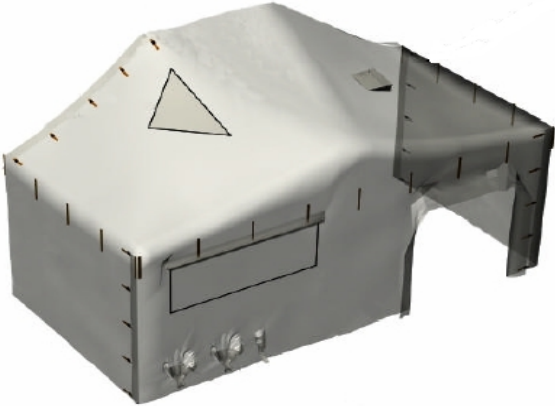
	NSN	DESCRIPTION	Photo
1.	8340-01-477-9567	CAMOUFLAGE GREEN #483 FABRIC ASSEMBLY, INTERMEDIATE SECTION, 18'	
2.	8340-01-477-9569	CAMOUFLAGE GREEN #483 FABRIC ASSEMBLY, END SECTION, 9'	

3.

[8340-01-491-1463](#)

DESERT TAN #459 FABRIC ASSEMBLY, INTERMEDIATE SECTION, 18'

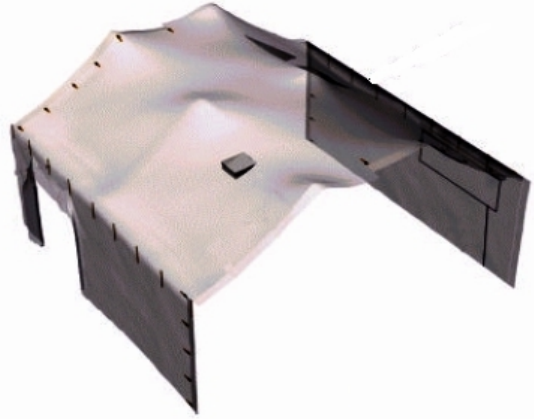

4.

[8340-01-491-1465](#)

DESERT TAN #459 FABRIC ASSEMBLY, END SECTION, 9'

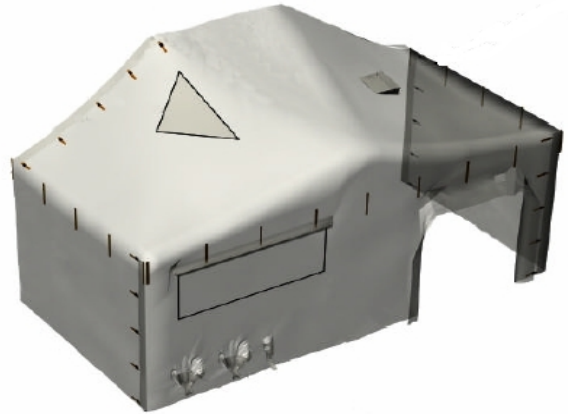

5.

[8340-01-477-1390](#)

LINER, INTERMEDIATE SECTION, SINGLE PLY FABRIC



6.

[8340-01-491-1392](#)

LINER, END SECTION, SINGLE PLY FABRIC



7.

[8340-01-491-1449](#)

FLOOR, INTERMEDIATE, COATED CLOTH, BLACK



8.

[8340-01-477-1397](#)

FLOOR, END SECTION, COATED CLOTH, BLACK



9.

[8340-01-491-0486](#)

KIT, REPAIR, FIELD EXPEDIANT



10.

[8340-01-477-9570](#)

POLE, "Y"ADJUSTABLE



11.

[8340-01-477-9566](#)

POLE, SIDE, W/GUY LINE ASSEMBLIES



12.

[8340-01-477-9525](#)

POLE, END W/GUY LINE ASSEMBLIES



13.

[8340-01-478-0136](#)

STAKE, HOLD DOWN 12" BLACK



17.

[8340-01-477-9564](#)

BAG, END POLE



18.

[8340-01-477-9561](#)

BAG, FABRIC ASSEMBLY END SECTION



19.

[8340-01-478-0022](#)

GUY, LINE, POLYESTER, BLACK, W/SLIP

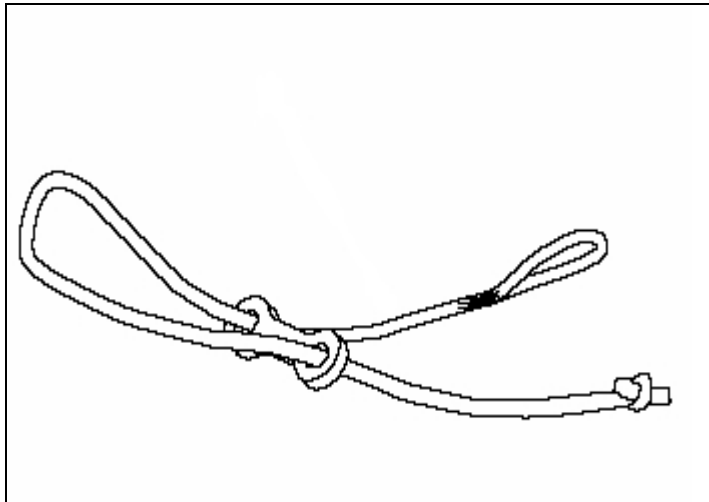

20.

[8340-01-186-3026](#)

Vestibule, Tent Size = BULE Green

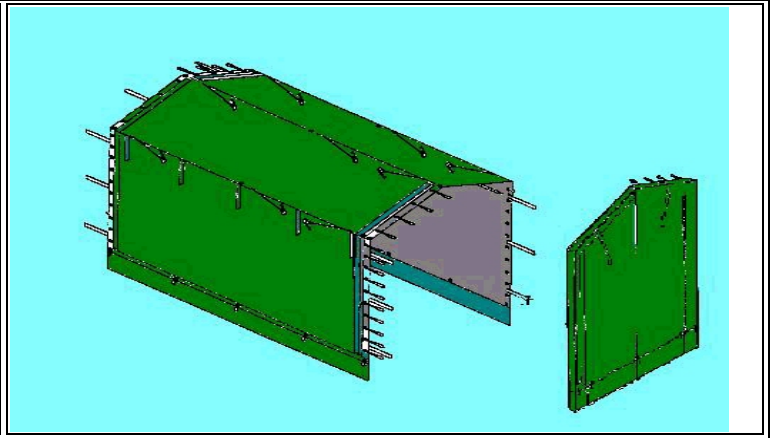

21.

[8340-01-198-7621](#)

Vestibule, Tent Size = BULE Tan

