

Frame Type Expandable Tent 16x32 System 2

[8340-01-503-3536 16' x 32' Camouflage Green Shade #483, Frame Type Expandable Tent](#)

The Frame Type Expandable Tent is a frame-supported tent consisting of an aluminum frame and a fabric covering of 16 oz. polyester duck. The end walls are laced to the two 16 foot long mid section fabrics that contains eight windows and four environmental control unit duct sleeves. The improved seaming construction is sealed to provide leak resistant interior. There is a heater stove pipe shield in the roof. The design now includes a full vinyl liner and fabric floor. Interior fabric color is white to provide better lighting distribution. Both the fabric and frame can be extended to any length in 16 foot sections. Field name is referred to as the "Aero-Fab."



SYSTEM 2 KEY FEATURES:

- Aluminum frame
- Improved polyester duck design. - User friendly design
- Windows w/screening on all sides
- Now leak resistant design
- Stove pipe openings and ECU Ducts - Quick mobility
- Camouflage Green coated polyester blackout fabric
- 512 square feet of floor space
- Modular design can be expanded in 16 ft increments to any length desired
- Rugged: maintains structural integrity in adverse weather conditions

System 2 Description:

The Camouflage Green Frame Type Expandable Tent has a polyester duck fabric covering and is frame-supported. The frame is of sectionalized aluminum construction composed of collapsible arches connected by 8 ft-long purlins and braced by header bars. The fabric end walls contain a window with screen, gable vents and U-Shaped Door. The end walls are laced to the two 16 foot long mid section fabrics that contains eight windows and four environmental control unit duct sleeves. Both the fabric and frame can be extended to any length in 16 foot sections. The tent has a floor space of 512 square feet (16'L x 32'W), 8'6" Ridge Height, and 6' Eave Height. It weighs 573 pounds and has shipping of 60 cu. Ft.

PRODUCT SPECIFICATIONS:

- **Dimensions:** 16'Length X 32'Width X 8'6"Ridge Height and 6'Eave Height
- **Floor Area:** 512 square feet
- **Weight:** 573 pounds
- **Color:** Camouflage Green
- **Set-up Time/# of Persons:** 60/4
- **Strike Time/# of Persons:** 25/4
- **Shipping Cube:** 60

Note: Ridge Line Find 20
(2 each) is part of expandable
mid fabric section find 2.

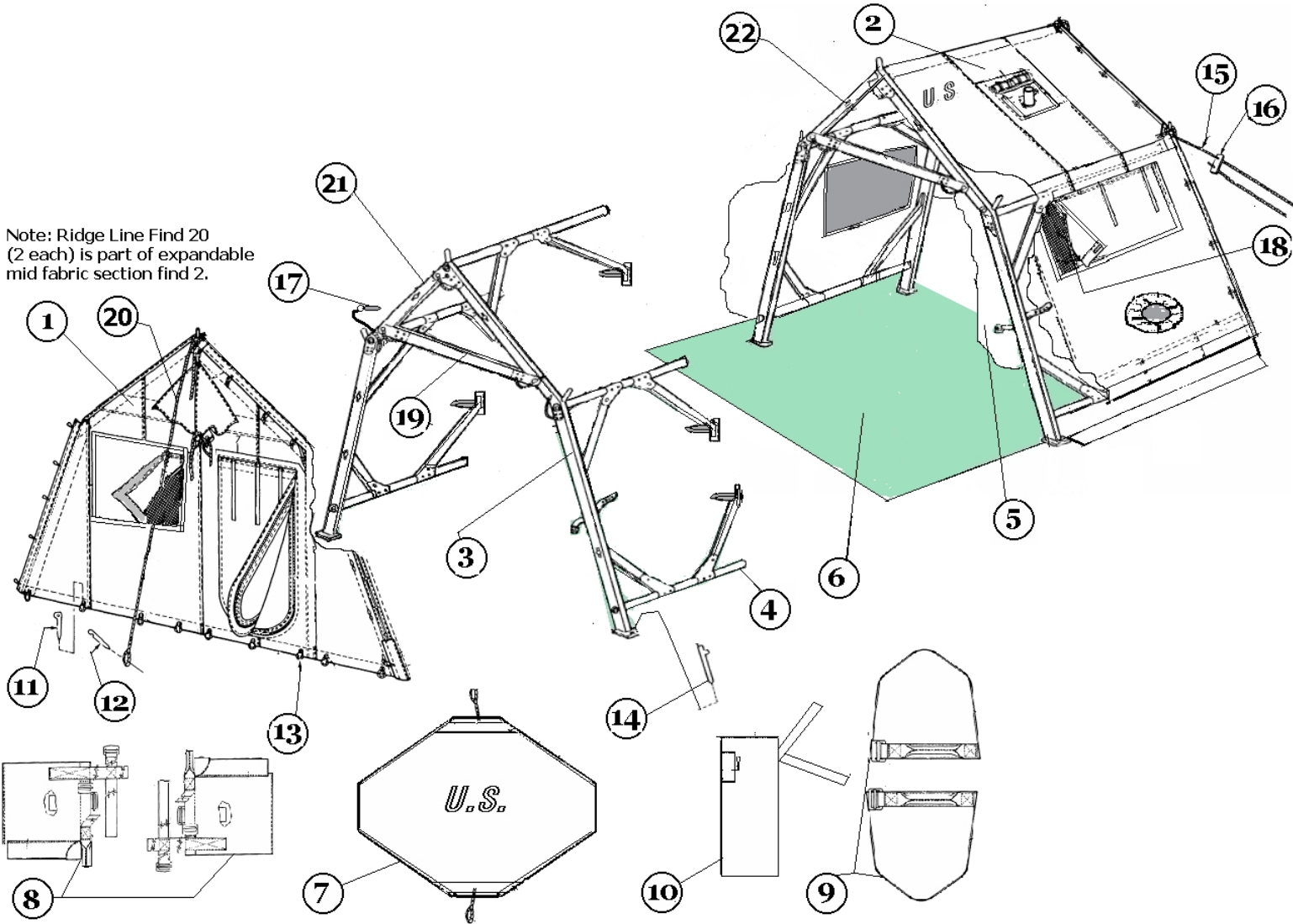

	Cut-Away View	
Find #	NSN	Nomenclature
1	8340-00-566-7398	END SECTION FABRIC Includes: 1 Guy Line, Eave Line 8', 8340-00-252-2269 9 Footstops, 9" 8340-00-252-2299
2	8340-00-566-7416	INTERMEDIATE SECTION FABRIC Includes: 18 Footstops, 9" 8340-00-252-2299 6 Guy Lines, Eave Line 8', 8340-00-252-2269 2 Guy Lines, Ridge Line, 13' 8340-00-252-2271 16 Inch Wood Pin 8340-00-261-9750 Window Pane 8340-00-566-7387
3	8340-00-566-7394	ARCH, TENT FRAME (Does Not Include Header)
4	8340-00-238-9806	PURLIN, ASSEMBLY
5	8340-01-452-7049	LINER ASSEMBLY (one pair- 8' long sections per tent)
6	8340-00-453-5646	FLOOR, 16' FABRIC
7	8340-00-841-4648	COVER, GENERAL PURPOSE, SMALL
8	8340-00-556-9671	TRANSPORT COVER, PURLINS (one cover = one pair with straps) (Fits 10 purlins per tent)
9	8340-00-556-9674	TRANSPORT COVER, ARCHES (one cover = one pair with straps)
10	8340-01-186-3030	BAG, PIN CONTAINER
11	8340-00-261-9749	9 INCH ALUMINUM PIN
12	8340-00-261-9750	16 INCH WOOD PIN
13	8340-00-252-2299	FOOTSTOP, 9"
14	8340-00-823-7451	12 INCH STEEL PINS, RED
15	8340-00-252-2269	EAVE LINE, TENT: GUY, 8'
16	8340-00-205-2759	SLIP, TENT LINE
17	5340-00-177-4076	PIN AND RING QUICK RELEASE
18	8340-00-566-7387	WINDOW, PANE
19	8340-00-556-9697	HEADER ASSEMBLY
20	8340-00-252-2271	RIDGE LINE, TENT: GUY 13'
21	8340-00-234-4712	EXPANDABLE SECTION FRAME Includes: 5 Purlin Assemblies 8340-00-238-9806 1 Arch Assembly 8340-00-566-7394 1 Header Assembly 8340-00-566-7387
22	8340-00-234-4708	END SECTION FRAME Includes: 5 Purlin Assemblies 8340-00-238-9806 2 Arch Assemblies 8340-00-566-7394 2 Header Assemblies 8340-00-566-7387



Frame Type Expandable Tent 16x32 System 2 includes the following:





	NSN	DESCRIPTION	QUANTITY
1.	8340-00-566-7398	End Section Fabric Includes: 1 Guy Line, Eave Line 8' 8340-00-252-2269 9 Footstops, 9" 8340-00-252-2299 Slip, Tent Line 8340-00-252-2269	2
2.	8340-00-566-7416	Intermediate Section Fabric Includes: 18 Footstops, 9" 8340-00-252-2299 6 Guy Lines, Eave Line 8' 8340-00-252-2269 2 Guy Lines, Ridge Line 13' 8340-00-252-2271 8 Tent, Line Slips 8340-00-205-2269 16 Inch Wood Pin 8340-00-261-9750 Window Pane 8340-00-566-7387	2
3.	8340-00-566-7394	ARCH, TENT FRAME (DOES NOT INCLUDE HEADER)	5
4.	8340-00-238-9806	PURLIN, ASSEMBLY	20
5.	8340-01-452-7049	Liner Assembly (one pair – 8' long sections per tent)	2
6.	8340-01-186-5646	Floor, 16' Fabric w/fastener tape. Mates to liner and extendable so two or more floors can be attached for longer tents.	2
7.	8340-00-841-4648	Cover, General Purpose, Small	2
8.	8340-00-556-9671	Transport Cover, Purlins (one cover = one pair with straps) Fits 10 purlins per tent	2
9.	8340-00-556-9674	Transport Cover, Arches (one cover = one pair with straps) Fits three arches and three header bars	2
10.	8340-01-186-3030	Bag, Pin Container	2
11.	8340-00-261-9749	9 Inch Aluminum Pin	18
12.	8340-00-261-9750	16 Inch Wood Pin	15
13.	8340-00-823-7451	12 Inch Steel Pin, Red	10
14.	8340-00-556-9697	Header Assembly	5

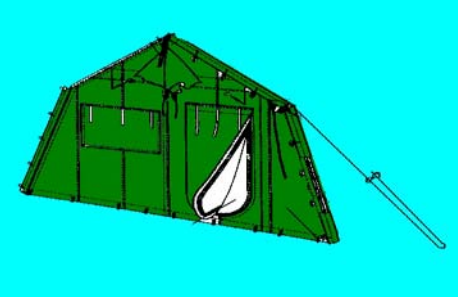
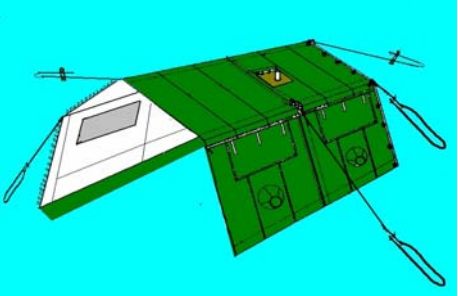
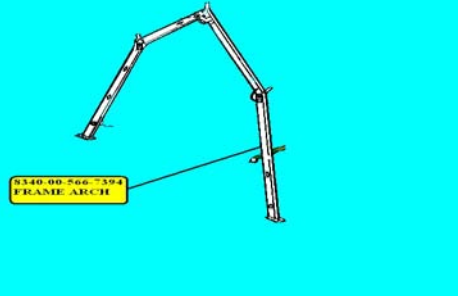

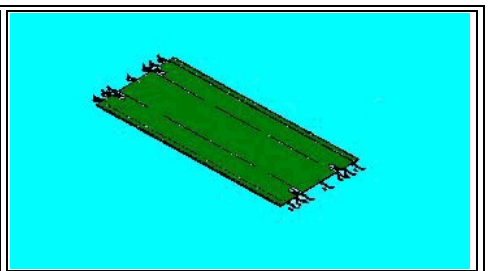
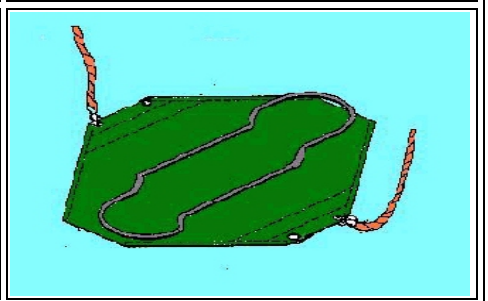

Buy System

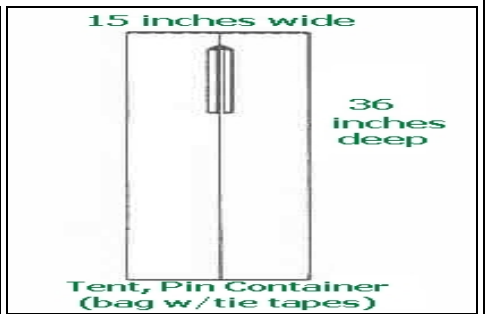
NSN	Description	Quantity
8340-01-503-3536	16' x 32' Camouflage Green Shade #483, Frame Type Expandable Tent	1

Spare Parts & Options for the 16x32:

	NSN	DESCRIPTION	Photo
1.	8340-00-566-7398	End Section Fabric Includes: 1 Guy Line, Eave Line 8' 8340-00-252-2269 9 Footstops, 9" 8340-00-252-2299 Slip, Tent Line 8340-00-252-2269	
2.	8340-00-566-7416	Intermediate Section Fabric Includes: 18 Footstops, 9" 8340-00-252-2299 6 Guy Lines, Eave Line 8' 8340-00-252-2269 2 Guy Lines, Ridge Line 13' 8340-00-252-2271 8 Tent, Line Slips 8340-00-205-2269 16 Inch Wood Pin 8340-00-261-9750 Window Pane 8340-00-566-7387	
3.	8340-00-566-7394	Arch, Tent Frame (Does Not Include Header)	
4.	8340-00-238-9806	Purlin, Assembly	
5.	8340-01-452-7049	LINER ASSEMBLY (one pair – 8' long sections per tent)	

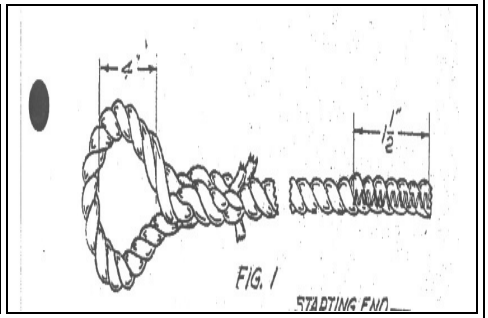
6.	8340-01-453-5646	Floor, 16' Fabric w/fastener tape. Mates to liner and extendable so two or more floors can be attached for longer tents.	
7.	8340-00-841-4648	Cover, General Purpose, Small	
8.	8340-00-556-9671	Transport Cover, Purlins (one cover = one pair with straps)	
9.	8340-00-556-9674	Transport Cover, Arches (one cover = one pair with straps)	
10.	8340-01-186-3030	Bag, Pin Container	<p>15 inches wide</p>  <p>36 inches deep</p> <p>Tent, Pin Container (bag w/tie tapes)</p>
11.	8340-00-261-9749	9 Inch Aluminum Pin	

12.	8340-00-261-9750	16 Inch Wood Pin	
13.	8340-00-252-2299	Footstop, 9"	
14.	8340-00-823-7451	12 Inch Steel Pin, Red	
15.	8340-00-252-2269	EAVE LINE, TENT: GUY, 8'	
16.	8340-00-205-2759	Slip, Tent Line	

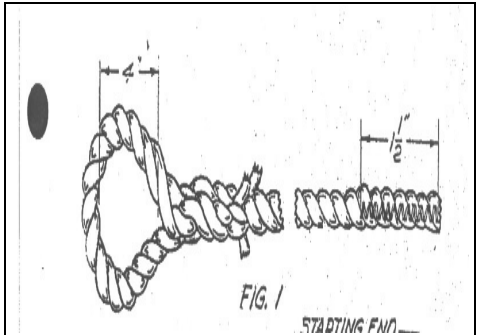
17.	5340-00-177-4076	Pin And Ring Quick Release	
18.	8340-00-566-7387	Window, Pane	
19.	8340-00-556-9697	Header Assembly	
20.	8340-00-252-2271	RIDGE LINE, TENT: GUY 13'	
21.	8340-00-234-4708	<p>End Section, Frame</p> <p>Includes:</p> <p>Header Assembly (2) 8340-00-234-9697,</p> <p>Arch, Tent Frame (2) 8340-00-566-7394,</p> <p>Purlin, Assembly (5) 8340-00-238-9806,</p> <p>12 Inch Steel Pins, Red 8340-01-823-7451</p> <p>Pin and Ring Quick Release 5340-00-177-4076</p>	

Expandable Section Frame

Includes:

Purlin, Assembly (5) [8340-00-238-9806](#),

Header Assembly (1) [8340-00-556-9697](#),

Arch, Tent Frame (1) [8340-00-566-7394](#),

12 Inch Steel Pins, Red [8340-00-823-7451](#)

Pin and Ring Quick

Release [5340-00-177-4076](#)

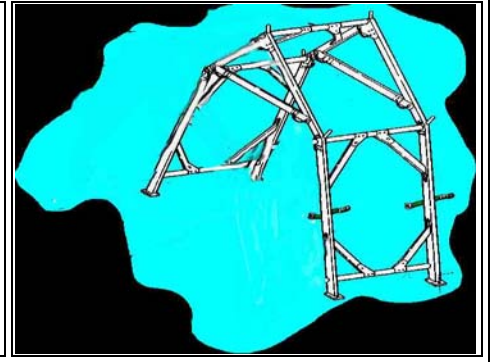

22. [8340-00-234-4712](#)